

Features

- High Gain: 24 dB
- P1dB: 34.8 dBm
- P3dB: 36 dBm
- IM3 Level: -23 dBc @ P_{OUT} = 30 dBm/tone
- Power Added Efficiency: 20% @ P3dB
- Temperature Compensated Output Power Detector
- Lead-Free 5 mm AQFN 32-lead Package
- RoHS* Compliant

Description

The MAAP-011250 is a balanced 4 W, 4-stage power amplifier assembled in a lead-free 5 mm 32-lead AQFN plastic package. This power amplifier operates from 27.5 to 30 GHz and provides 24 dB of linear gain, 4 W saturated output power and 20 % efficiency while biased at 6 V.

The MAAP-011250 can be used as a power amplifier stage or as a driver stage in higher power applications. This device is ideally suited for VSAT and 28 GHz PTP applications.

This product is fabricated using a GaAs pHEMT process which features full passivation for enhanced reliability.

Ordering Information^{1,2}

Part Number	Package
MAAP-011250-TR0500	500 Piece Reel
MAAP-011250-SMB	Sample Board

1. Reference Application Note M513 for reel size information.
2. All sample boards include 3 loose parts.

Functional Schematic

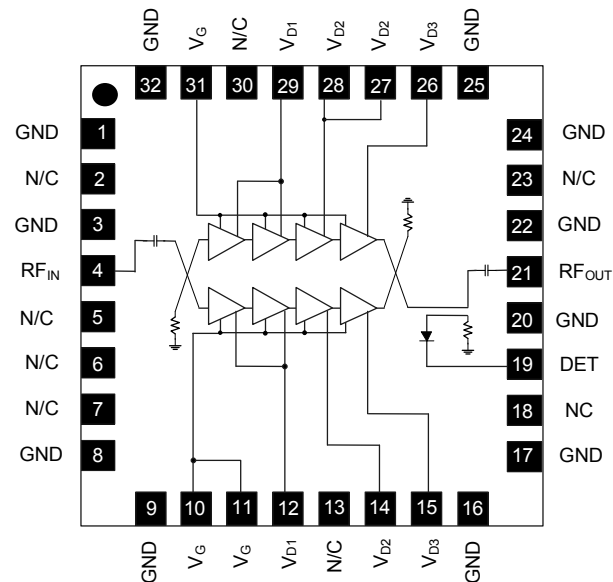

Pin Configuration^{3,4}

Pin #	Pin Name	Description
1, 3, 8, 9, 16, 17, 20, 22, 24, 25, 32	GND	Ground
2, 5, 6, 7, 13, 18, 23, 30	N/C	No Connection
4	RF _{IN}	RF Input
10, 11, 31	V _G	Gate Voltage
12, 29	V _{D1}	Drain Voltage 1
14, 27, 28	V _{D2}	Drain Voltage 2
15, 26	V _{D3}	Drain Voltage 3
19	DET	Detector
21	RF _{OUT}	RF Output

3. MACOM recommends connecting all No Connection (N/C) pins to ground.
4. The exposed pad centered on the package bottom must be connected to RF, DC and thermal ground.

* Restrictions on Hazardous Substances, compliant to current RoHS EU directive.

Power Amplifier, 4 W 27.5 - 30 GHz

Rev. V1

Electrical Specifications: Freq. = 27.5 & 30 GHz, $T_A = +25^\circ\text{C}$, $V_D = 6\text{ V}$, $Z_0 = 50\ \Omega$

Parameter	Test Conditions	Units	Min.	Typ.	Max.
Gain	$P_{IN} = 0\text{ dBm}$, 27.5 GHz $P_{IN} = 0\text{ dBm}$, 30.0 GHz	dB	21.0 21.0	26.0 24.5	—
P_{OUT}^5	$P_{IN} = 14.5\text{ dBm}$, 27.5 GHz $P_{IN} = 15.0\text{ dBm}$, 30.0 GHz	dBm	34.5 34.5	37.0 36.0	—
IM3	$P_{OUT} = 30\text{ dBm / tone}$ Freq. = 27.5 - 30 GHz	dBc	—	-23	—
Power Added Efficiency	$P_{IN} = 14.5\text{ dBm}$ Freq. = 27.5 - 30 GHz	%	—	20	—
Input Return Loss	$P_{IN} = -20\text{ dBm}$ Freq. = 27.5 - 30 GHz	dB	—	15	—
Output Return Loss	$P_{IN} = -20\text{ dBm}$ Freq. = 27.5 - 30 GHz	dB	—	15	—
Quiescent Current	I_{DSQ} (see bias conditions, page 4)	mA	—	2300	—
Drain Current ($V_{D1} + V_{D2} + V_{D3}$)	$P_{IN} = 14.5\text{ dBm}$	mA	—	3600	4300

5. MACOM does not recommend sustained operation at power levels above 3 dB gain compression.

Maximum Operating Ratings

Parameter	Rating
Input Power ⁵	15 dBm
Junction Temperature ^{6,7}	+160°C
Operating Temperature	-40°C to +85°C

6. Operating at nominal conditions with junction temperature $\leq +160^\circ\text{C}$ will ensure MTTF $> 1 \times 10^6$ hours.
7. Junction Temperature (T_J) = $T_C + \Theta_{JC} * ((V * I) - (P_{OUT} - P_{IN}))$
Typical thermal resistance (Θ_{JC}) = 4°C/W .
- a) For $T_C = +25^\circ\text{C}$
 $T_J = +88^\circ\text{C}$ @ 6 V, 3.3 A, $P_{OUT} = 36\text{ dBm}$, $P_{IN} = 14.5\text{ dBm}$
- b) For $T_C = +85^\circ\text{C}$
 $T_J = 146^\circ\text{C}$ @ 6 V, 3.0 A, $P_{OUT} = 34.5\text{ dBm}$, $P_{IN} = 14.5\text{ dBm}$

Handling Procedures

Please observe the following precautions to avoid damage:

Static Sensitivity

These electronic devices are sensitive to electrostatic discharge (ESD) and can be damaged by static electricity. Proper ESD control techniques should be used when handling these HBM Class 1A devices.

Absolute Maximum Ratings^{8,9}

Parameter	Absolute Maximum
Input Power	17.5 dBm
Drain Voltage	+6.5 V
Gate Voltage	-3 to 0 V
Junction Temperature ¹⁰	+175°C
Storage Temperature	-65°C to +125°C

8. Exceeding any one or combination of these limits may cause permanent damage to this device.
9. MACOM does not recommend sustained operation near these survivability limits.
10. Junction temperature directly effects device MTTF. Junction temperature should be kept as low as possible to maximize lifetime.

2

MACOM Technology Solutions Inc. (MACOM) and its affiliates reserve the right to make changes to the product(s) or information contained herein without notice. Visit www.macom.com for additional data sheets and product information.

Sample Board Layout

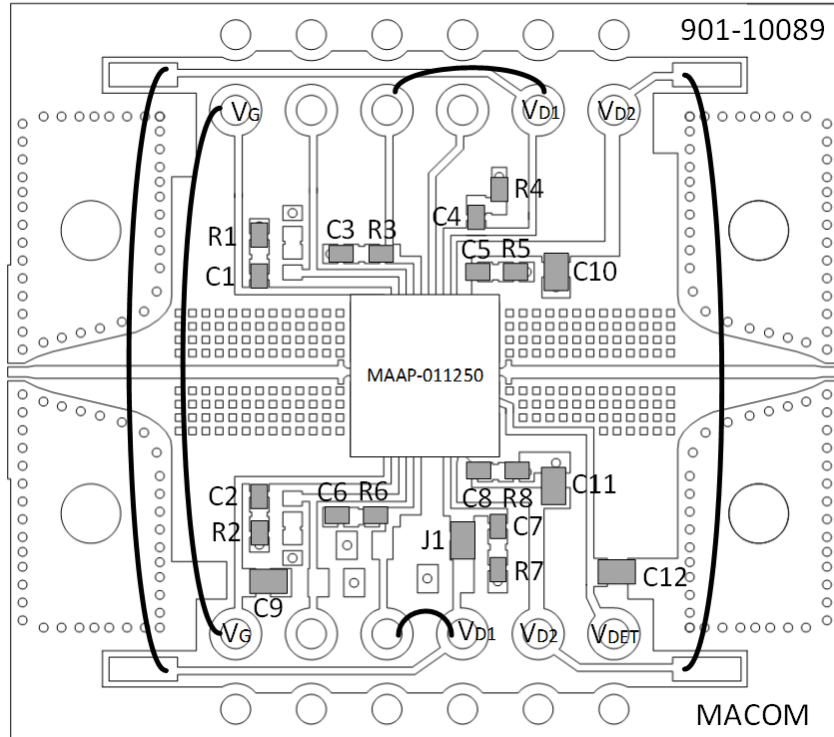

Application Schematic

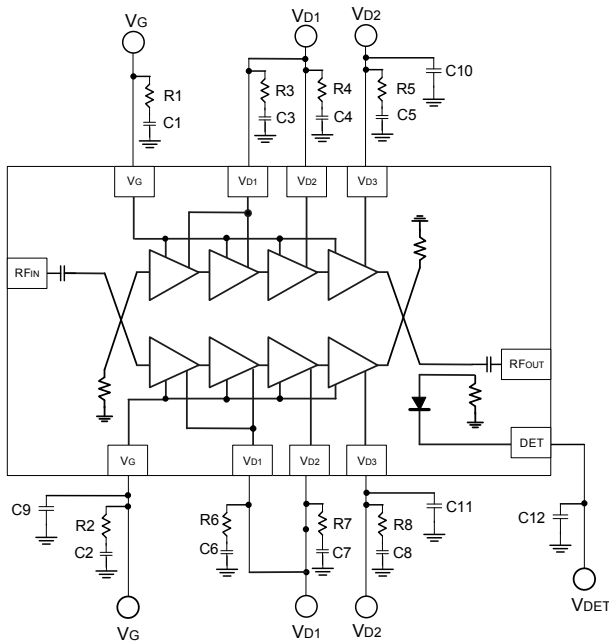

Parts List

Part	Value	Case Style
C1 - C8	0.01 μ F	0402
C9 - C12	22 μ F	0603
R1 - R8	10 Ω	0402
J1	jumper	0603

Sample Board Material Specifications

Top Layer: 1/2 oz Copper Cladding, 0.017 mm thickness
 Dielectric Layer: Rogers RO4003C 0.203 mm thickness
 Bottom Layer: 1/2 oz Copper Cladding, 0.017 mm thickness
 Finished overall thickness: 0.238 mm

Recommended PCB Layout Detail:

RF input and output pre-matching circuit patterns are identical and are designed to compensate packaging effects. Transmission line dimensions apply to a PCB with 0.203 mm thick Rogers RO4003C laminate dielectric. Performance curves shown in this data sheet were measured with these circuit patterns.

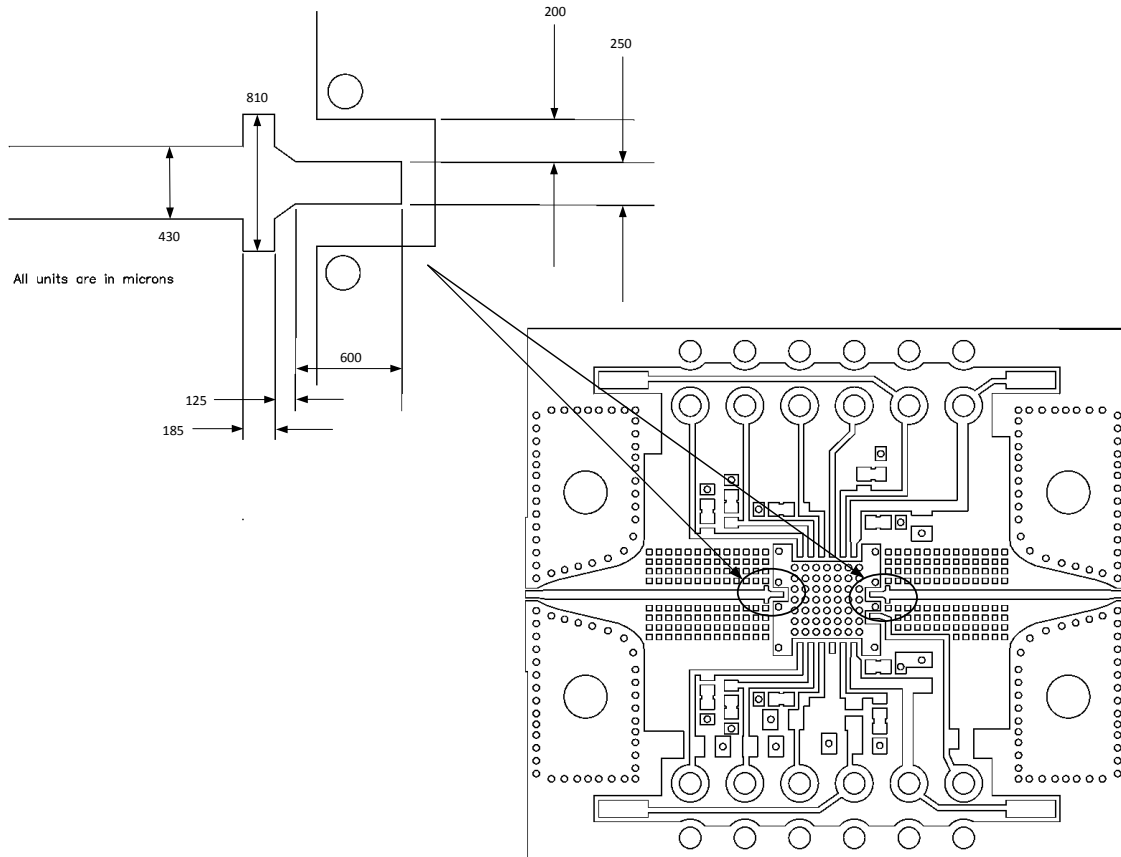

Biasing Conditions

Recommended biasing conditions are $V_D = 6\text{ V}$, $I_{DSQ} = 2.3\text{ A}$ (controlled with V_G). The drain bias voltage range is 3 to 6 V, and the quiescent drain current biasing range is 2 to 2.5 A.

V_G pins 10 and 11 are connected internally but are not connected to pin 31; V_G bias must be applied to pins 31 and 10 or 11. Muting can be accomplished by setting the V_G to the pinched off voltage ($V_G = -2\text{ V}$).

V_D bias must be applied to all V_{DX} pins (V_{D1} , V_{D2} , and V_{D3}) on both sides of device as these pins are not internally connected.

Operating the MAAP-011250

Turn-on

1. Apply V_G (-1.5 V).
2. Apply V_D (6.0 V typical).
3. Set I_{DQ} by adjusting V_G more positive (typically -0.9 to -1.0 V for $I_{DSQ} = 2.3\text{ A}$).
4. Apply RF_{IN} signal.

Turn-off

1. Remove RF_{IN} signal.
2. Decrease V_G to -1.5 V.
3. Decrease V_D to 0 V.

Typical Performance Curves: $V_D = 6\text{ V}$, $I_{DSQ} = 2300\text{ mA}$

Small Signal Gain vs. Frequency over Temperature

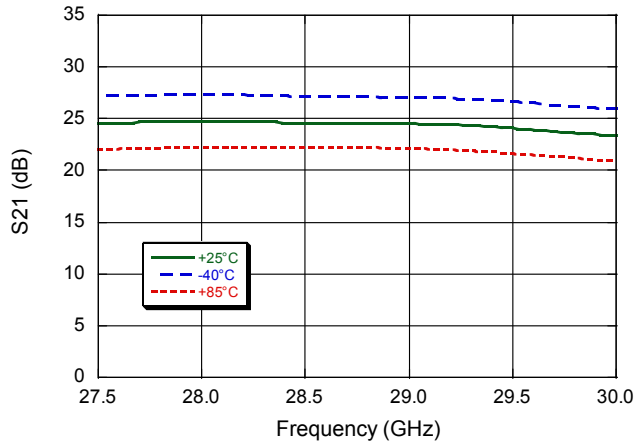

Small Signal Gain vs. Frequency over Bias Voltage

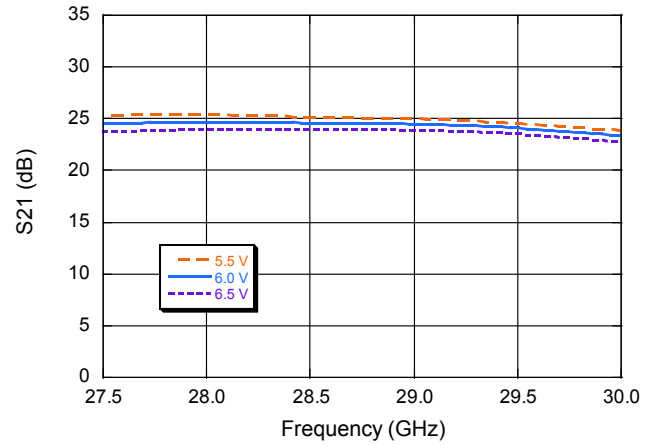

Input Return Loss vs. Frequency over Temperature

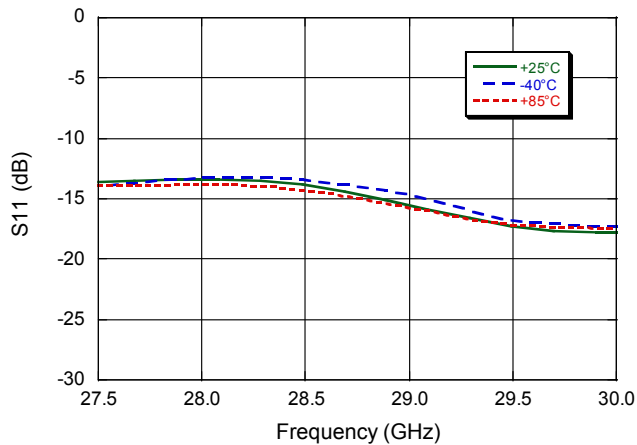

Input Return Loss vs. Frequency over Bias Voltage

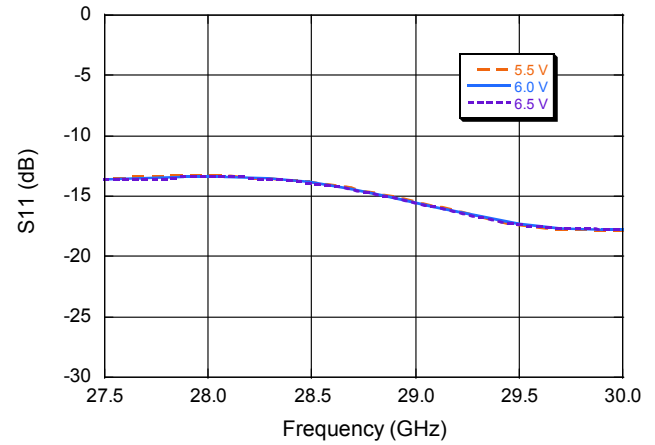

Output Return Loss vs. Frequency over Temperature

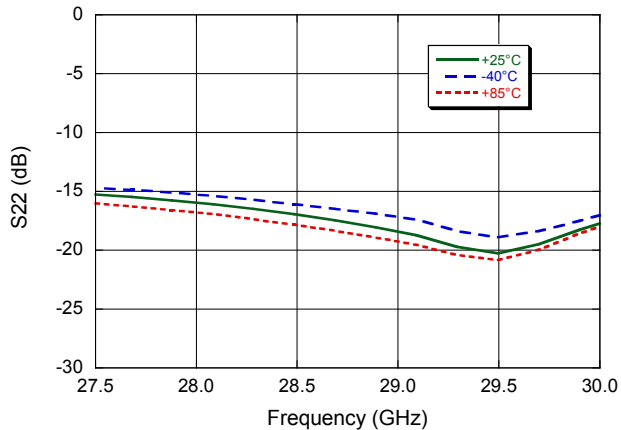

Output Return Loss vs. Frequency over Bias Voltage

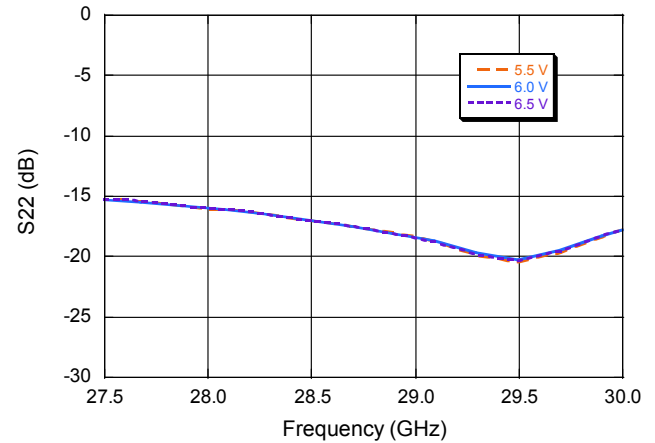

Typical Performance Curves: $V_D = 6\text{ V}$, $I_{DSQ} = 2300\text{ mA}$

P3dB vs. Frequency over Temperature

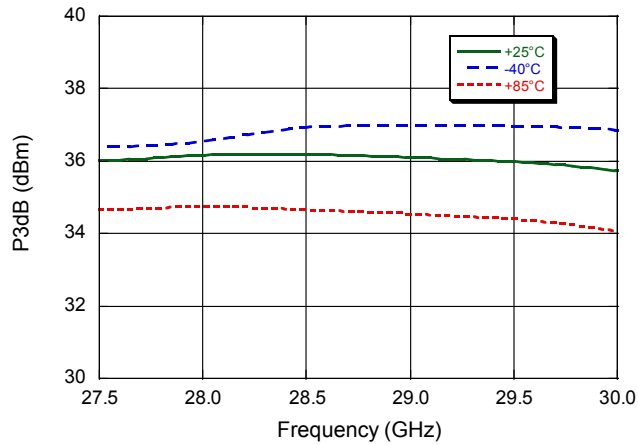

P3dB vs. Frequency over Bias Voltage

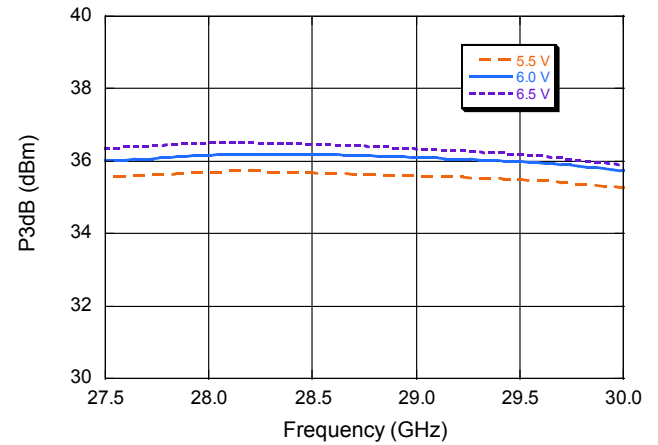

P1dB vs. Frequency over Temperature

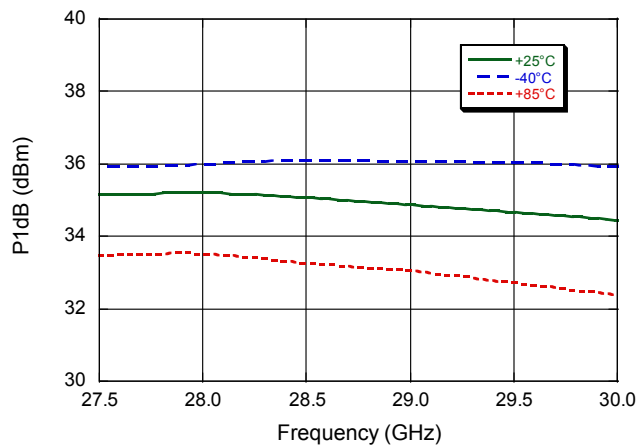

P1dB vs. Frequency over Bias Voltage

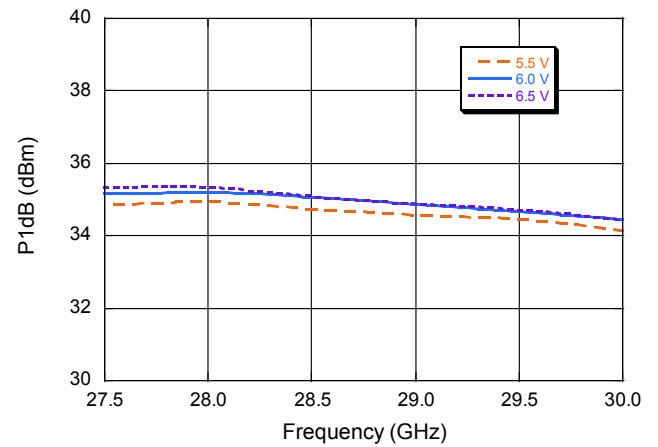

Typical Performance Curves: $V_D = 6\text{ V}$, $I_{DSQ} = 2300\text{ mA}$

Output IP3 over Temperature ($P_{OUT} = 30\text{ dBm / Tone}$)

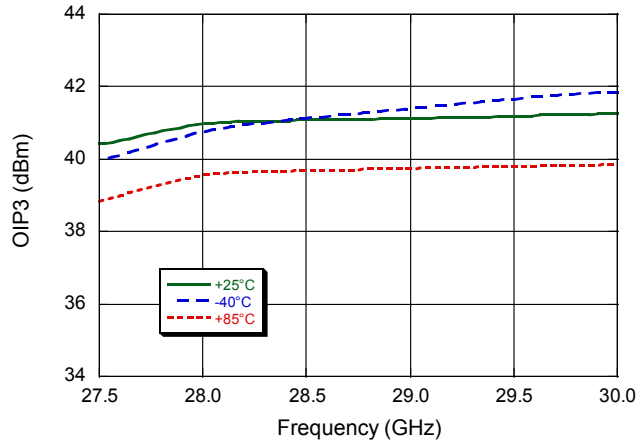

Output IP3 over Bias Voltage ($P_{OUT} = 30\text{ dBm / Tone}$)

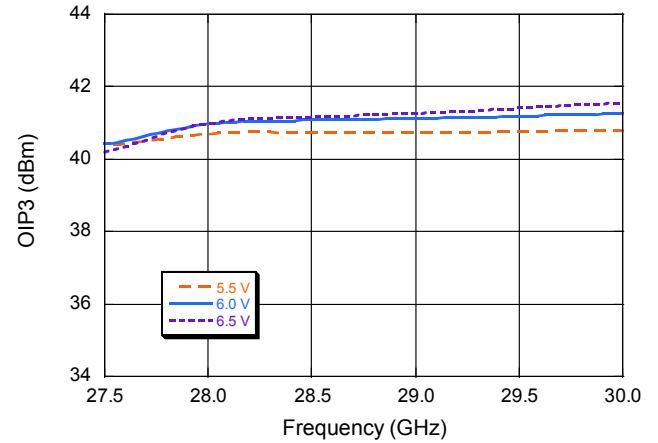

IM3 over Temperature ($P_{OUT} = 30\text{ dBm / Tone}$)

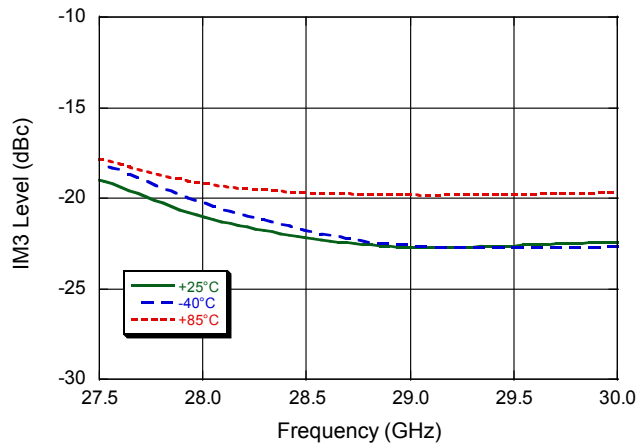

IM3 over Bias Voltage ($P_{OUT} = 30\text{ dBm / Tone}$)

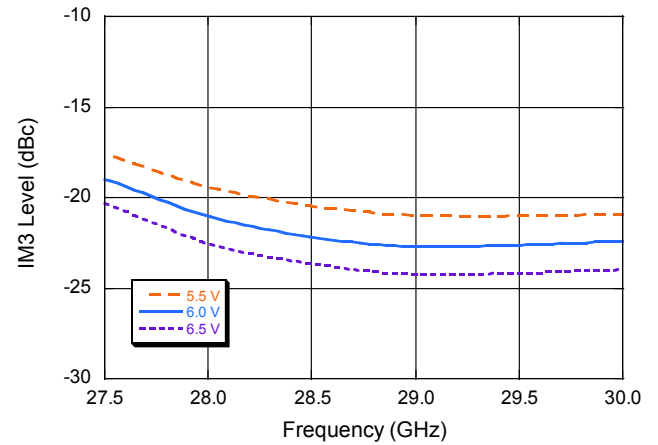

Typical Performance Curves: $V_D = 6\text{ V}$, $I_{DSQ} = 2300\text{ mA}$

P1dB, P3dB vs. Frequency

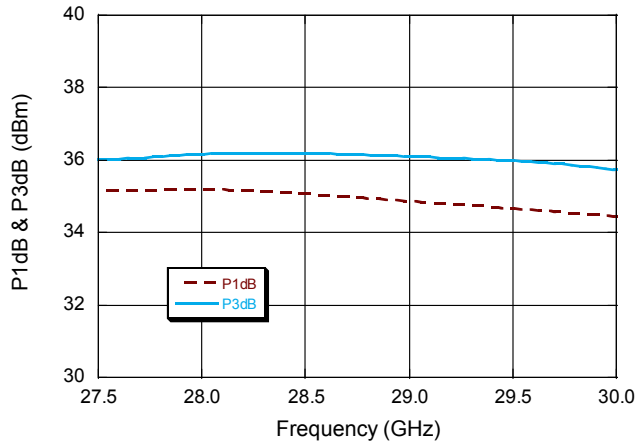

Gain and PAE @ P3dB vs. Frequency

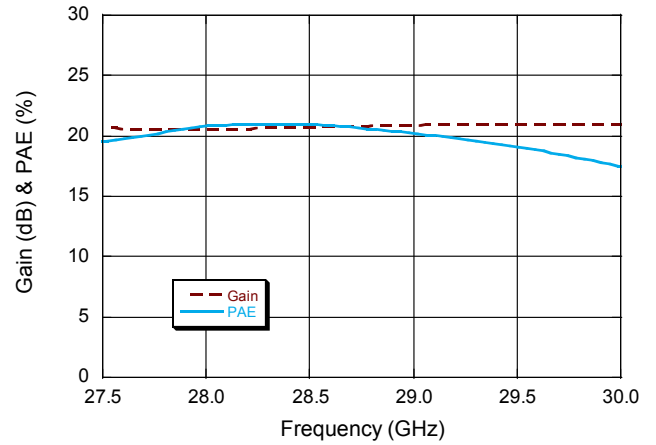

IM3 vs. Output Power

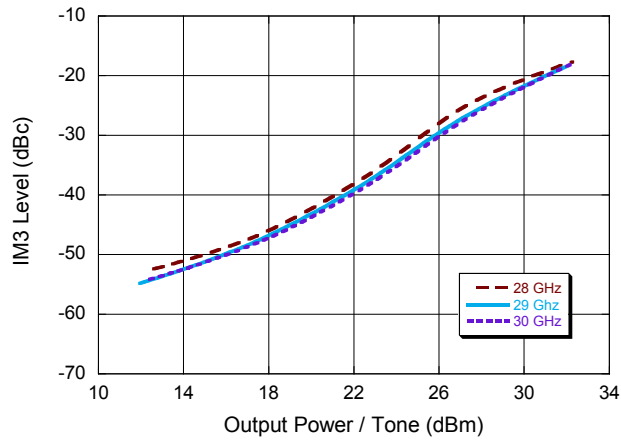

Output IP3 vs. Output Power

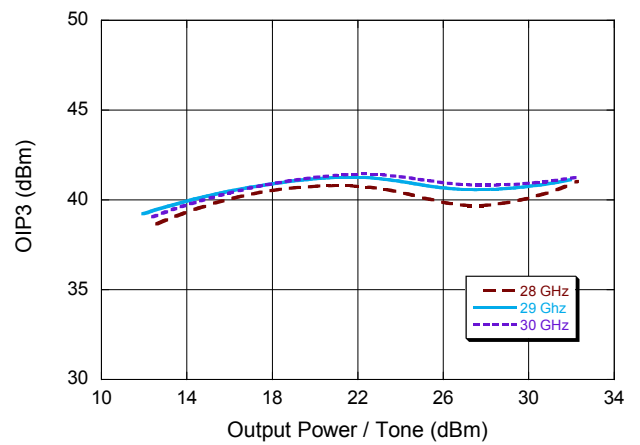

Typical Performance Curves: $V_D = 6\text{ V}$, $I_{DSQ} = 2300\text{ mA}$

Output Power vs. Input Power

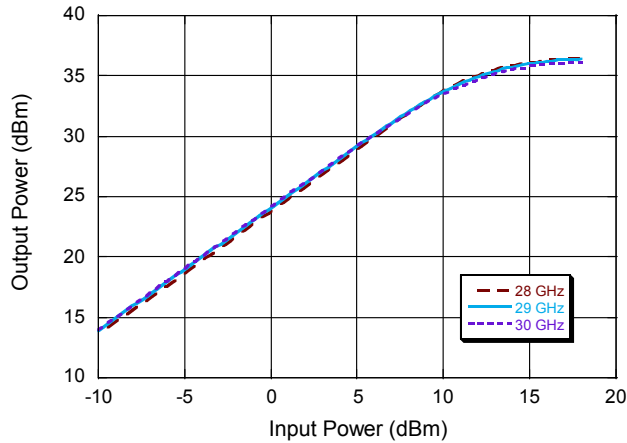

PAE vs. Input Power

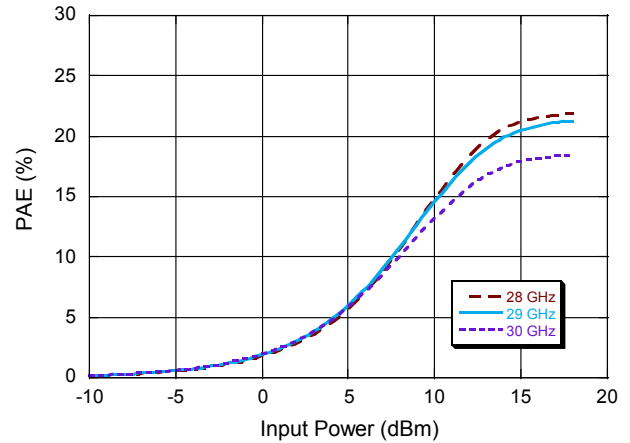

Bias Current vs. Input Power

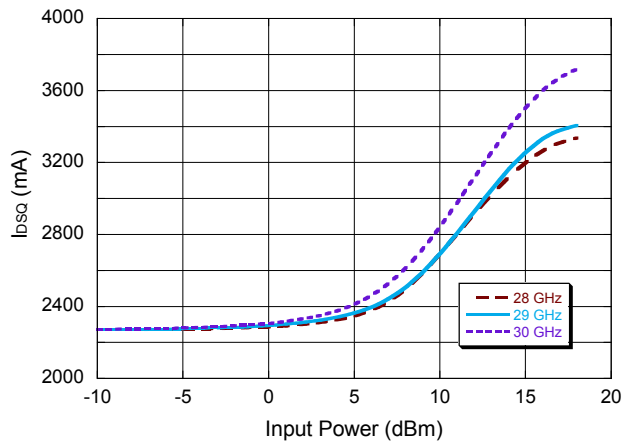

Quiescent Drain Current vs. Temperature

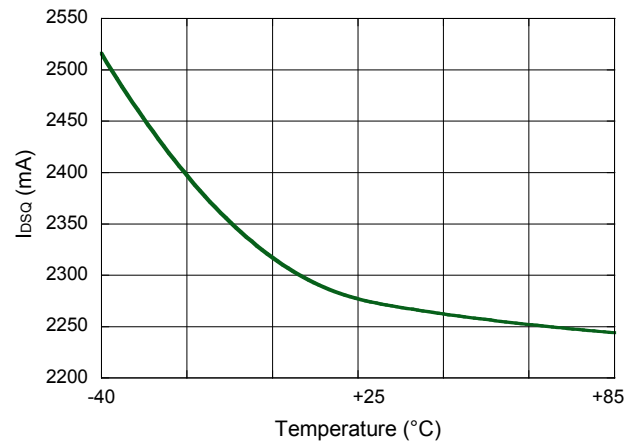

Detector Voltage vs. Output Power @ 29 GHz

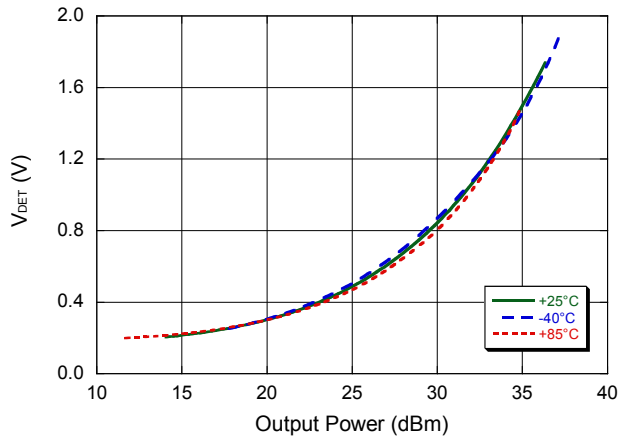

Lead-Free 5 mm 32-Lead AQFN Package[†]

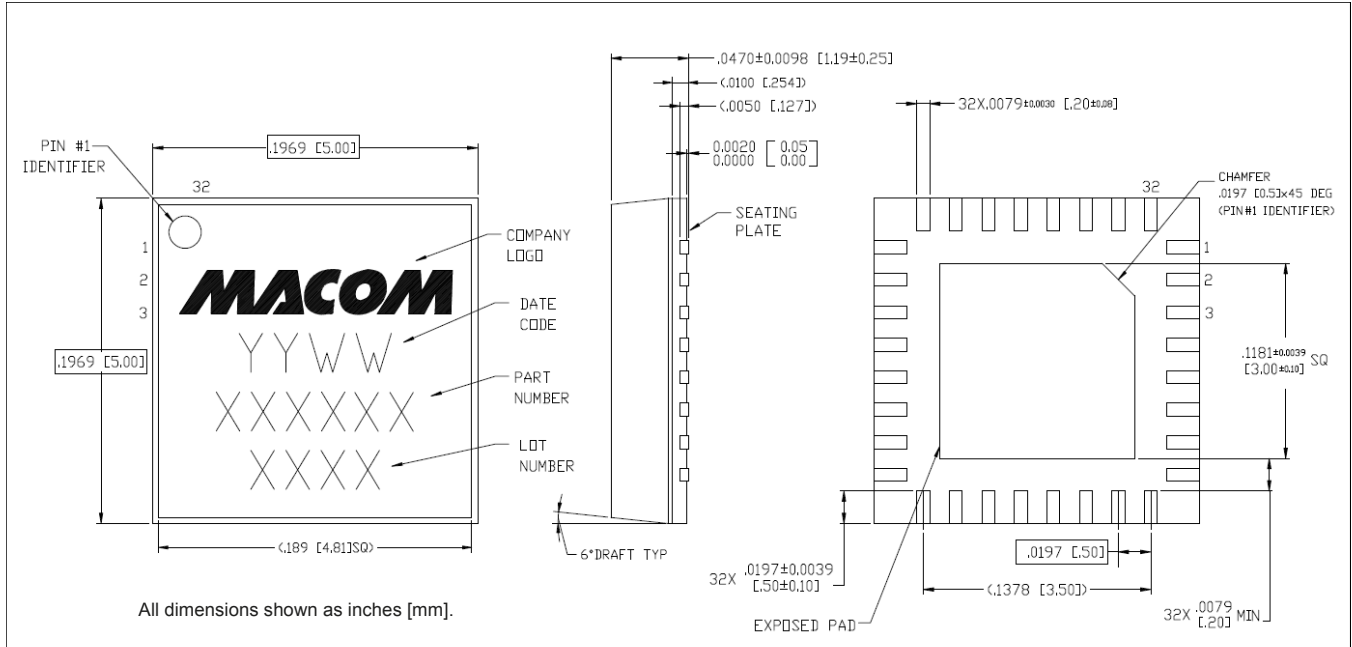

[†] Reference Application Note S2083 for lead-free solder reflow recommendations.
Meets JEDEC moisture sensitivity level 3 requirements.
Plating is NiPdAu.

MACOM Technology Solutions Inc. All rights reserved.

Information in this document is provided in connection with MACOM Technology Solutions Inc ("MACOM") products. These materials are provided by MACOM as a service to its customers and may be used for informational purposes only. Except as provided in MACOM's Terms and Conditions of Sale for such products or in any separate agreement related to this document, MACOM assumes no liability whatsoever. MACOM assumes no responsibility for errors or omissions in these materials. MACOM may make changes to specifications and product descriptions at any time, without notice. MACOM makes no commitment to update the information and shall have no responsibility whatsoever for conflicts or incompatibilities arising from future changes to its specifications and product descriptions. No license, express or implied, by estoppel or otherwise, to any intellectual property rights is granted by this document.

THESE MATERIALS ARE PROVIDED "AS IS" WITHOUT WARRANTY OF ANY KIND, EITHER EXPRESS OR IMPLIED, RELATING TO SALE AND/OR USE OF MACOM PRODUCTS INCLUDING LIABILITY OR WARRANTIES RELATING TO FITNESS FOR A PARTICULAR PURPOSE, CONSEQUENTIAL OR INCIDENTAL DAMAGES, MERCHANTABILITY, OR INFRINGEMENT OF ANY PATENT, COPYRIGHT OR OTHER INTELLECTUAL PROPERTY RIGHT. MACOM FURTHER DOES NOT WARRANT THE ACCURACY OR COMPLETENESS OF THE INFORMATION, TEXT, GRAPHICS OR OTHER ITEMS CONTAINED WITHIN THESE MATERIALS. MACOM SHALL NOT BE LIABLE FOR ANY SPECIAL, INDIRECT, INCIDENTAL, OR CONSEQUENTIAL DAMAGES, INCLUDING WITHOUT LIMITATION, LOST REVENUES OR LOST PROFITS, WHICH MAY RESULT FROM THE USE OF THESE MATERIALS.

MACOM products are not intended for use in medical, lifesaving or life sustaining applications. MACOM customers using or selling MACOM products for use in such applications do so at their own risk and agree to fully indemnify MACOM for any damages resulting from such improper use or sale.