

## General Description

The AOZ8S207BLS-01 is a single channel transient voltage suppressor designed to protect data lines such as USB 3.1 and other very high speed data lines from damaging ESD events.

This device incorporates two unidirectional TVS diodes with a back-to-back in a single package. During transient conditions, the bidirectional diodes direct the transient to either the positive side of the power supply line or to ground.

The AOZ8S207BLS-01 provides a typical capacitance of 0.1pF and low clamping voltage making it ideally suited for data transmission protection in mobile and computing devices.

The AOZ8S207BLS-01 comes in a RoHS compliant and Halogen Free 0.6mm x 0.3mm x 0.3mm package and is rated for -40°C to +125°C junction temperature range.

## Features

- ESD protection for high-speed data lines:
  - IEC 61000-4-2, ESD immunity
  - Air discharge: ±16kV
  - Contact discharge: ±16kV
  - IEC61000-4-5 (Lightning) 5A (8/20µs)
  - Human Body Model (HBM) ±8kV
- Bidirectional TVS
- Low capacitance: 0.15pF
- Low breakdown voltage: 1.5V
- Low operating voltage: 1V

## Applications

- USB 3.1 Gen 1 & Gen 2, USB3.2
- Thunderbolt 2.0, 3.0 and 4.0
- Mobile Phone
- Notebook computers



## Typical Application

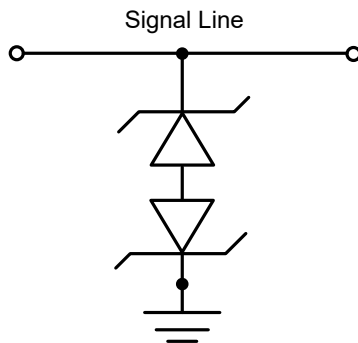

## Pin Configuration

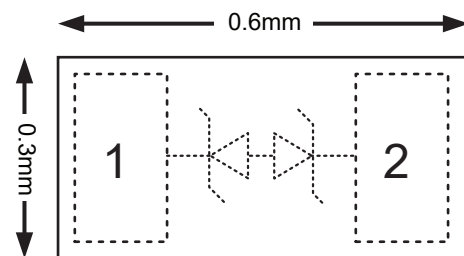

## Ordering Information

Part Number	Ambient Temperature Range	Package	Environmental
AOZ8S207BLS-01	-40°C to +125°C	WLCSP0.6×0.3_2L	Green Product



AOS Green Products use reduced levels of Halogens, and are also RoHS compliant. Please visit [www.aosmd.com/media/AOSGreenPolicy.pdf](http://www.aosmd.com/media/AOSGreenPolicy.pdf) for additional information.

## Absolute Maximum Ratings

Exceeding the Absolute Maximum ratings may damage the device.

Parameter	Rating
Any Pin to Pin	1.0V
Peak Pulse Current ( $I_{PP}$ ), $t_P = 8/20\mu s$	5A
Peak Pulse Power ( $P_{PP}$ ), $t_P = 8/20\mu s$	28W
Storage Temperature ( $T_S$ )	-65 °C to +150°C
ESD Rating per IEC61000-4-2, Contact <sup>(1)</sup>	±16kV
ESD Rating per IEC61000-4-2, Air <sup>(1)</sup>	±16kV
ESD Rating per Human Body Mode <sup>(2)</sup>	±8kV

### Notes:

- IEC 61000-4-2 discharge with  $C_{Discharge} = 150\text{pF}$ ,  $R_{Discharge} = 330\Omega$ .
- Human Body Discharge per MIL-STD-883, Method 3015  $C_{Discharge} = 100\text{pF}$ ,  $R_{Discharge} = 1.5\text{k}\Omega$ .

## Maximum Operating Conditions

The device is not guaranteed to operate beyond the Maximum Recommended Operating Conditions.

Parameter	Rating
Junction Temperature ( $T_J$ )	-40 °C to +125°C

## Electrical Characteristics

T<sub>A</sub> = 25°C, unless otherwise specified. Any I/O to I/O.

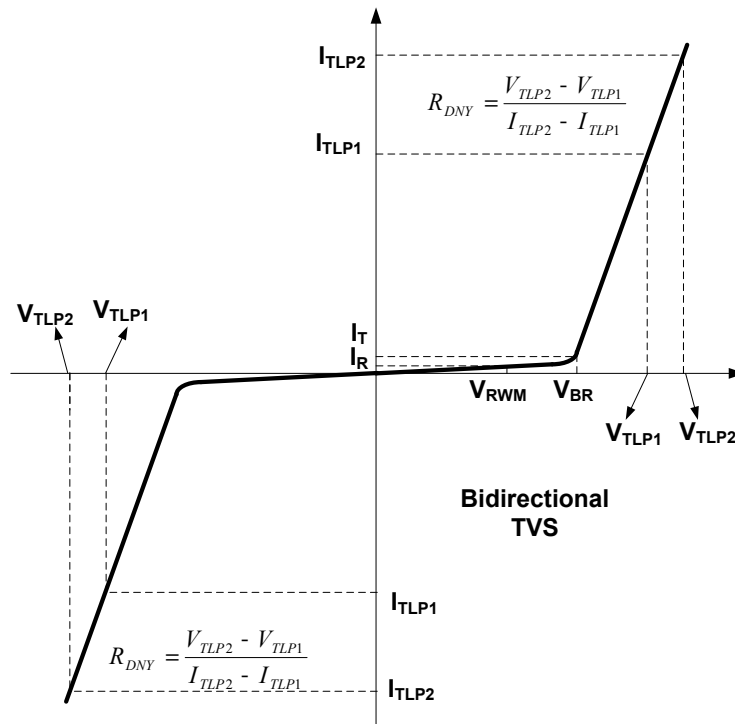

Symbol	Parameter	Conditions	Min	Typ	Max	Units
V <sub>RWM</sub>	Reverse Working Voltage				1	V
V <sub>BR</sub>	Reverse Breakdown Voltage	I <sub>T</sub> = 100µA	1.3	1.5	2.3	V
I <sub>R</sub>	Reverse Leakage Current	Max. V <sub>RWM</sub>		50	500	nA
V <sub>CL</sub>	Clamping Voltage <sup>(3)(4)</sup> (100ns Standard Transmission Line Pulse)	I <sub>TLP</sub> = 1A		2.8		V
		I <sub>TLP</sub> = 8A		5		
		I <sub>TLP</sub> = 16A		7		
V <sub>CL</sub>	Clamping Voltage <sup>(3)</sup> (IEC61000-4-5 1.2/50µs & 8/20µs)	I <sub>PP</sub> = 2A		3.8		V
		I <sub>PP</sub> = 5A		5.6		
R <sub>DNY-TLP</sub>	Dynamic Resistance <sup>(3)(4)</sup>	I <sub>TLP</sub> = 1 to 16A		0.29		Ω
C <sub>J</sub>	Junction Capacitance	V <sub>I/O</sub> = 0V, f = 1MHz		0.15	0.195	pF

**Notes:**

3. These specifications are guaranteed by design and characterization.
4. Measurements performed using a 100 ns Transmission Line Pulse (TLP) system.

## Typical Characteristics Performance

**Positive Transmission Line Pulse**  
( $t_p = 100\text{ ns}$ ,  $t_r = 0.2\text{ ns}$ )

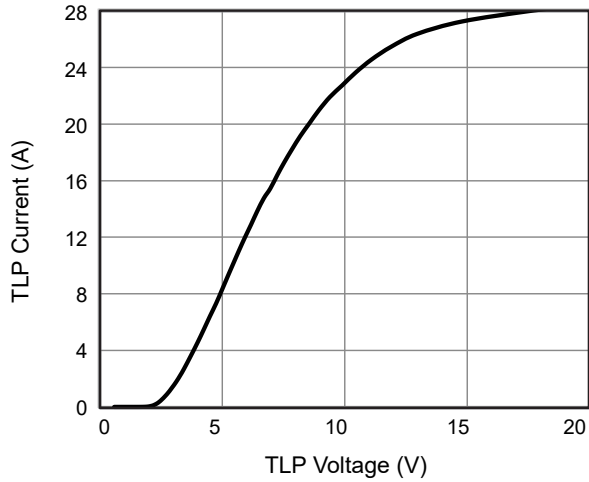

**Negative Transmission Line Pulse**  
( $t_p = 100\text{ ns}$ ,  $t_r = 0.2\text{ ns}$ )

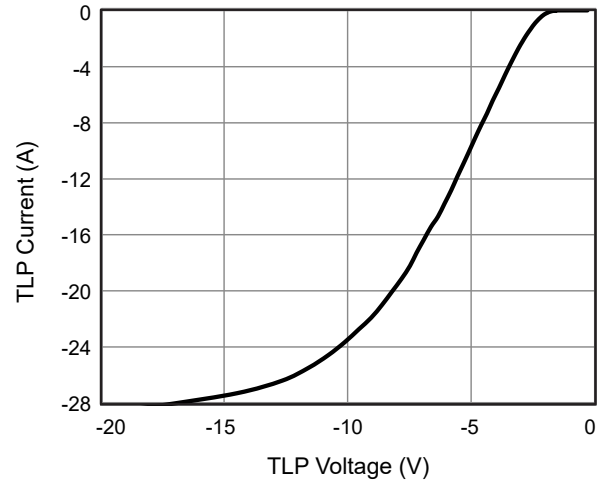

**Typical Variations of  $C_J$  vs. Input Voltage**

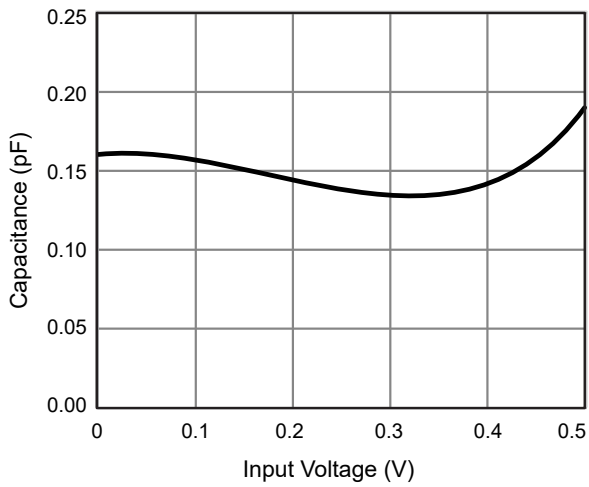

**IEC61000-4-5 Surge 8/20 $\mu$ s (Any Pin to Pin)**

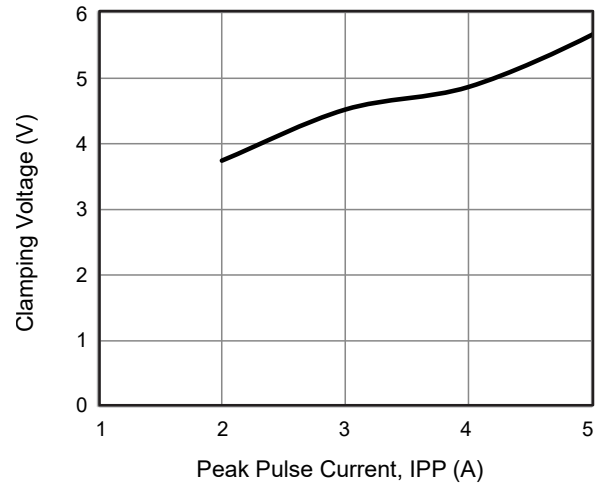

## Typical Characteristics Performance (Continued)

### USB3.2 Gen2 Eye Diagram (10Gbps)



### HDMI2.1 Eye Diagram (12Gbps)

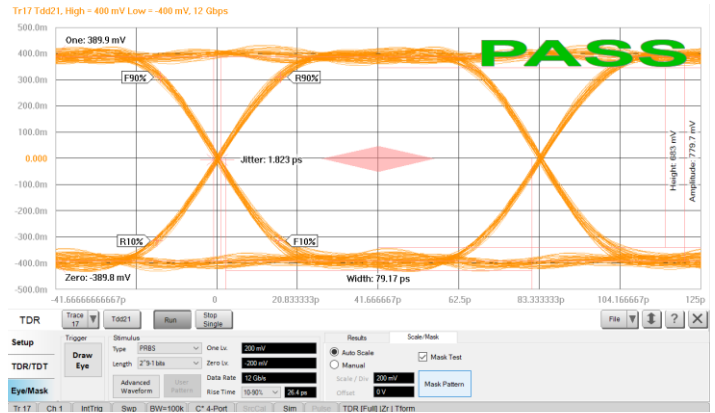

### Thunderbolt 3.0 Eye Diagram (20Gbps)

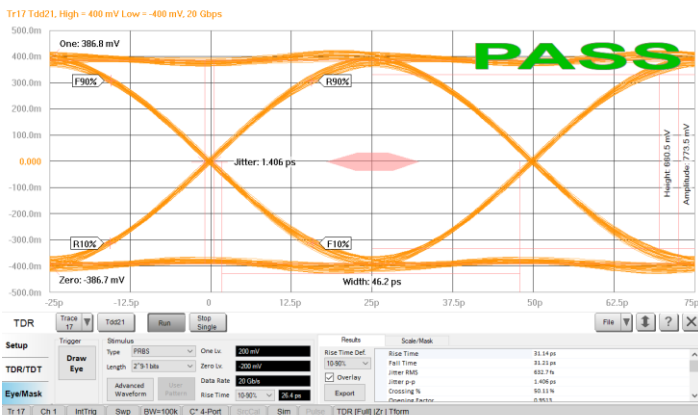

## LEGAL DISCLAIMER

Applications or uses as critical components in life support devices or systems are not authorized. Alpha and Omega Semiconductor does not assume any liability arising out of such applications or uses of its products. AOS reserves the right to make changes to product specifications without notice. It is the responsibility of the customer to evaluate suitability of the product for their intended application. Customer shall comply with applicable legal requirements, including all applicable export control rules, regulations and limitations.

AOS's products are provided subject to AOS's terms and conditions of sale which are set forth at:

[http://www.aosmd.com/terms\\_and\\_conditions\\_of\\_sale](http://www.aosmd.com/terms_and_conditions_of_sale)

## LIFE SUPPORT POLICY

ALPHA AND OMEGA SEMICONDUCTOR PRODUCTS ARE NOT AUTHORIZED FOR USE AS CRITICAL COMPONENTS IN LIFE SUPPORT DEVICES OR SYSTEMS.

As used herein:

1. Life support devices or systems are devices or systems which, (a) are intended for surgical implant into the body or (b) support or sustain life, and (c) whose failure to perform when properly used in accordance with instructions for use provided in the labeling, can be reasonably expected to result in a significant injury of the user.
2. A critical component in any component of a life support, device, or system whose failure to perform can be reasonably expected to cause the failure of the life support device or system, or to affect its safety or effectiveness.